



Upgrade
YOUR SPACE
with Smart Designs.

Premium Materials • Modern Designs • Exceptional Finish



COMPANY PROFILE

We are an ISO 9001:2015 Certified company engaged as hardware product manufacturer in india and supplying all kind of screw, drawer channel and many more hardware products.

Leaving on the vast experience of 20+ years in this field. We have emerged as a prominent organization engaged in manufacturing and supplying a wide gamut of hardware products. We employee advance machinery and equipment to manufacture with international and national quality standards. Our quality of these products on various parameters to ensure their excellent quality.





Mission

Our mission at MG is to revolutionize the Hardware industry by providing innovative and high-quality product that strengthen the bond between individuals and their possessions. We are committed to delivering reliable and efficient solutions that meet the diverse needs of our customers across various industries. Through continuous innovation, exceptional craftsmanship, and unparalleled dedication, we strive to exceed expectations and set new standards of excellence in the fasteners market.



Vision

At MG, our vision is to be the leading global provider of screws, renowned for our commitment to quality, innovation, and customer satisfaction. We aim to expand our presence in key markets while maintaining our focus on delivering superior products and services. By fostering a culture of collaboration, integrity, and continuous improvement, we aspire to drive positive change and create lasting value for our customers, employees, and stakeholders. Together, we envision a future where MG is synonymous with reliability, excellence, and trust in the fasteners industry.

Luxury Kitchen & Wardrobe Fitting



Know a little about..

Enhance your kitchen with innovative storage systems designed for convenience and efficiency. From corner units and cutlery organizers to dish racks and pull-out drawers, every solution is crafted to maximize space, improve organization, and add a modern touch to your kitchen.

Index

KITCHEN STORAGE SYSTEMS

Sophisticated spaces designed
for comfort and luxury.



M-TEK Standard Drawer Slide

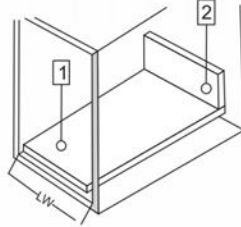

1. LW - Inside Cabinet Width

Bottom panel width = Inside Cabinet width - 19 ± 0.5
 Bottom Panel length = Runner length - 10mm

2. Back Panel Height = 63mm

Bottom panel width = Inside Cabinet width - 42 ± 0.5
 Bottom Panel length = Runner length - 46 ± 0.5



Suitable for Drawer Depth : 500 mm
 Weight Capacity : 45 Kgs.
 Full extension with soft closing system
 3D Adjustments

SPECIFICATION

Item	Height	Colour
SLIM BOX	88mm	Matte Grey
SLIM BOX	120mm	Matte Grey
SLIM BOX	168mm	Matte Grey
SLIM BOX	199mm	Matte Grey

Available depth 300mm, 350mm, 400mm,
 450mm, 500mm, 550mm & 600mm

Components

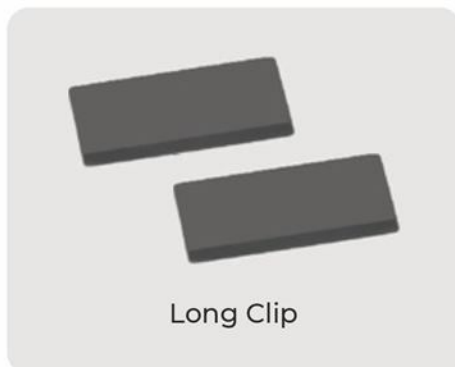
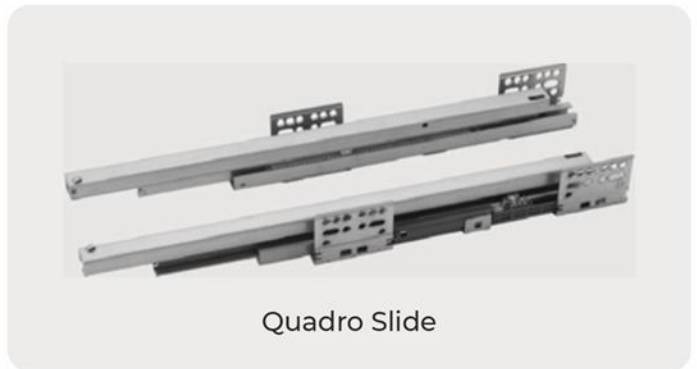
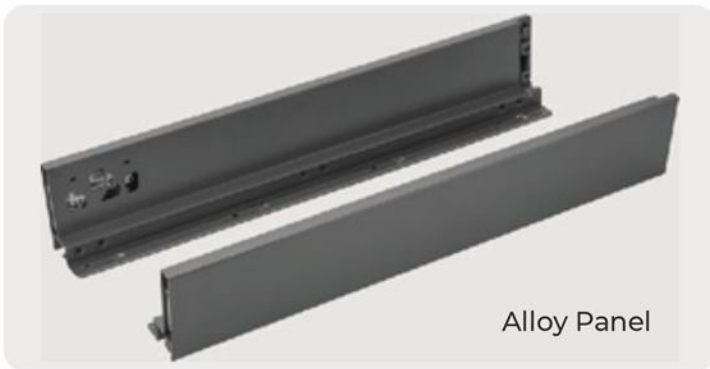

G-TEK Side Glass Drawer Slide

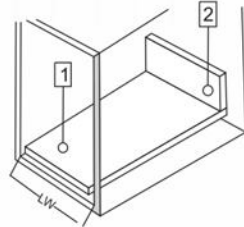

1. LW (Internal Cabinet Width)

Bottom Panel = LW - 19 mm

Panel Depth = Runner Length - 10 mm

Back Height : 63 mm

Bottom Panel = LW - 42 mm

Panel Depth = Runner Length - 46 mm



Suitable for Drawer Depth : 500 mm

Weight Capacity : 40 Kgs.

Full extension with soft closing system

3D Adjustments

SPECIFICATION

Item	Height	Colour
GLASS BOX	84mm	Matte Grey
GLASS BOX	116mm	Matte Grey
GLASS BOX	167mm	Matte Grey
GLASS BOX	199mm	Matte Grey

Available depth 500mm

➤ 2 side glass for an elegant look, convenient storage of medium heighted containers.

➤ Combination of high quality metal panels with glass





Bottle Pull Out (Glass)

Shelf	Cabinet Size	W X D X H mm
2/3Shelf	150 mm	150 x 485 x 495/585 mm
2/3Shelf	200 mm	200 x 485 x 495/585 mm
2/3Shelf	250 mm	250 x 485 x 495/585 mm
2/3Shelf	300 mm	300 x 485 x 495/585 mm



Bottle Pull Out (Flat Line)

Shelf	Cabinet Size	W X D X H mm
2/3Shelf	150 mm	150 x 485 x 495/585 mm
2/3Shelf	200 mm	200 x 485 x 495/585 mm
2/3Shelf	250 mm	250 x 485 x 495/585 mm
2/3Shelf	300 mm	300 x 485 x 495/585 mm



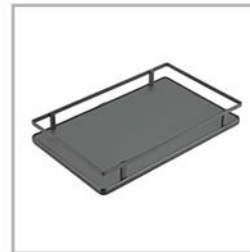

Pantry Unit (Glass/Flatline)

Model	Size	Height
6 Shelf	450 mm	1800-2100 mm
6 Shelf	600 mm	1800-2100 mm

An Essential Storage Solution In
Modern Kitchens, Designed To Maximize
Space And Organization.

Features

- Space optimization
- Storage versatility
- Smooth Functionality
- Material & Build Quality
- Customization & Aesthetics
- Smart storage solutions



Tall Unit (Glass)

Model	Size	Height
6 Layer	200 mm	1800-2100 mm
6 Layer	250 mm	1800-2100 mm
6 Layer	300 mm	1800-2100 mm

An Essential Storage Solution In
Modern Kitchens, Designed To Maximize
Space And Organization.

Features

- ✎ Space optimization
- ✎ Storage versatility
- ✎ Smooth Functionality
- ✎ Material & Build Quality
- ✎ Customization & Aesthetics
- ✎ Smart storage solutions

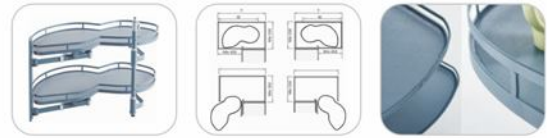

Swing Corner (Grey)

Item No.	FIT mm	W X D X H mm
112901	900 mm	830 X 520 X (600~750) mm

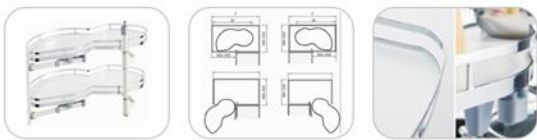

Swing Corner (White)

Item No.	FIT mm	W X D X H mm
112902	900 mm	830 X 520 X (600~750) mm



Universal Magic Corner

Item No.	FIT mm	W X D X H mm
112801	900 mm	610 X 495 X 510 mm



Wicker Basket (PVC)

Finish	Honey
Materia	PVC
Size	450 mm / 600 mm



Wicker Basket (Wood)

Finish	Steam Beach
Materia	Wood
Size	450 mm / 600 mm



Wicker Basket (Soft Close)

Finish	Honey
Materia	PVC
Size	450 mm / 600 mm



Rolling Shutter (PVC)

Carcase Size	Colour	W X D X H mm
450 mm	Black	450 x 1320 mm
450 mm	Silver	450 x 1320 mm
600 mm	Black	600 x 1320 mm
600 mm	Silver	600 x 1320 mm



Rolling Shutter (Glass)

Carcase Size	Colour	W X D X H mm
600 mm	Black	600 x 1320 mm
600 mm	White	600 x 1320 mm



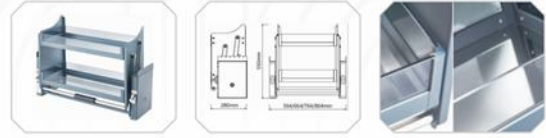

Adjustable Pull Down Basket (Glass)

Item No.	FIT mm	W X D X H mm
113301	600 mm	564 X 280 X 550 mm
113302	900 mm	864 X 280 X 550 mm

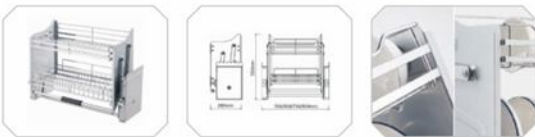

Adjustable Wire Pull Down Basket (ss)

Item No.	FIT mm	W X D X H mm
113401	600 mm	564 X 280 X 550 mm
113402	900 mm	864 X 280 X 550 mm



Deep hole thread- Tightly engaged
8 holes need to be Drilled

Glass & Plate Tray (ss)

Cabinet Size	W X D X H mm
600 mm	565 x 280 x 65 mm
700 mm	665 x 280 x 65 mm
800 mm	765 x 280 x 65 mm
900 mm	865 x 280 x 65 mm
1000 mm	965 x 280 x 65 mm



Bifold Liffup

Width	600-900 mm & 900-1200 mm
Height	Min. 400 mm / Max 700 mm
Capacity	7-8 kg / 10-11 kg

Aut Lid Bin (ss)

Finish	Capacity	Size
Chrome	8ltr	300 X 300 X 280 mm
Chrome	14ltr	320 X 360 X 360 mm



Double Sliding Waste Bin

Finish	Black
Material	PVC
Capacity	11ltr + 11ltr
Size	250 X 452 X 365 mm

Cutlery Tray



Cutlery Tray (Pvc)

Carcase Size	W X D X H mm
450 mm	450 x 535 x 60 mm
500 mm	500 x 535 x 60 mm
600 mm	600 x 535 x 60 mm
700 mm	700 x 535 x 60 mm
800 mm	800 x 535 x 60 mm
900 mm	900 x 535 x 60 mm



Cutlery Tray (Wooden)

Finish	Steam Beach
Material	Wooden
Size	450mm-600mm (Adjustable) 600mm-900mm (Adjustable)



Deep hole thread- Tightly engaged
8 holes need to be Drilled

Cutlery Divider (Metal)

Finish	W X D mm
Grey Finish	600 x 500 mm
Grey Finish	900 x 500 mm



Cup & Thali Fitment (ss)

Model	Size	Finish
Cup Saucer	500 / 550 mm	Chrome
Thali	500 / 550 mm	Chrome



Cup & Thali Fitment (ABS)

Model	Size	Finish
Cup Saucer	500 / 550 mm	Grey
Thali	500 / 550 mm	Grey

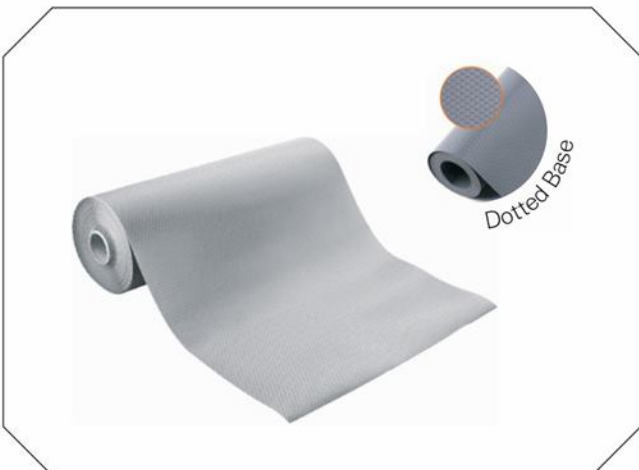

Anti Skid Matt

Finish	Grey
Depth	500 / 550mm
Size	5 mtr.

WARDROBE STORAGE SYSTEM

Where elegance and organization
come together beautifully.

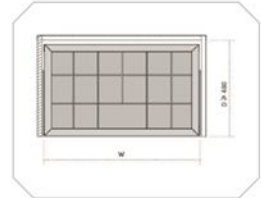

Garnishry Drawer (Mocha / Grey)

Item No.	Fit mm	W X D X H mm
220103	600 mm	564 x 465 x 76 mm
220104	900 mm	864 x 465 x 76 mm



Retractable Garnishry Drawer (Mocha / Grey)

Item No.	W X D X H mm
220201	112 x 420 x 80 mm



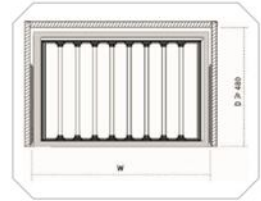

Trouser Rack (Mocha / Grey)

Item No.	Fit mm	W X D X H mm
220303	600 mm	564 x 465 x 76 mm
220304	900 mm	864 x 465 x 76 mm

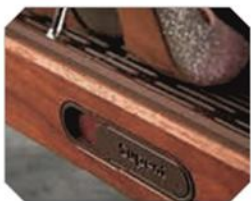

Shoe Rack (Mocha / Grey)

Item No.	Size
220403	600 mm
220404	900 mm



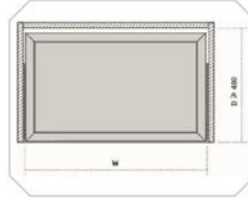

Rattan Basket (Mocha / Grey)

Item No.	Fit mm	W X D X H mm
220503	600 mm	564 x 465 x 170 mm
220504	900 mm	864 x 465 x 170 mm

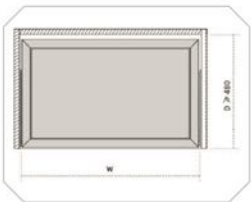

Glass Basket (Mocha / Grey)

Item No.	Size
220603	600 mm
220604	900 mm





Clothes Holder (Mocha / Grey)

Item No.	W x D x H mm
220702	115 x 455 x 115 mm

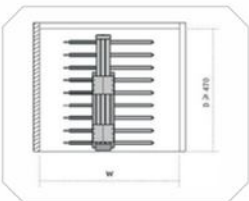

Trouser Rack Single V-Line (Mocha / Grey)

Item No.	W X D X H mm
220802	340 x 455 x 140 mm





Watch Winder (Mocha / Grey)

Item No.	Fit mm	W X D X H mm
220901	900 mm	860 x 300 x 200 mm



Leather Basket (Mocha / Grey)

Item No.	Fit mm	W X D X H mm
221001	600 mm	564 x 465 x 170 mm
201002	900 mm	864 x 465 x 170 mm

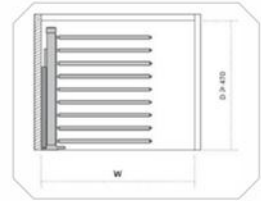
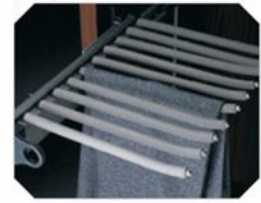

Lateral Pants Rack (Mocha / Grey)

Item No.	W X D X H mm
221102	380 x 475 x 170 mm

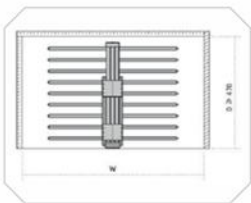

Trouser Rack Double Line (Mocha / Grey)

Item No.	W x D x H mm
221201	630 x 455 x 115 mm



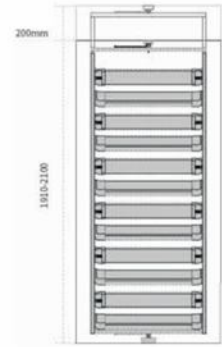
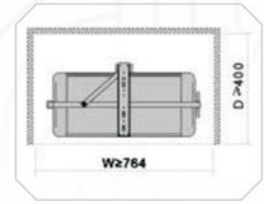

360° Rotating Shoe Rack (Mocha / Grey)

Item No.	W x D x H mm
221301	700 x 360 x 1910-2110 mm



Pullout Mirror (Mocha / Grey)

Item No.	Fit mm	W X D X H mm
221402	350 mm	1000 x 350 mm



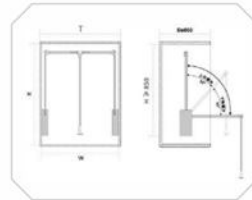

Wardrobe Lifter (Mocha / Grey)

Item No.	Fit mm	W X D X H mm
221501	900 mm	830 x 1150 mm



Folding Ironing Board (Grey)

Item No.	W x D x H mm
221601	295 x 140 mm

PREMIUM HARDWARE FITTING

Create more space, comfort, and
everyday convenience.





Drawer Slide Ultra (35kg)

Packing	15 Sets/Ctn
Available Size	8" to 24"
Finish	Zinc/Black

Drawer Slide Premium Plus (45kg)

Packing	15 Sets/Ctn
Available Size	8" to 24"
Finish	Zinc/Black



Drawer Slide Silencio (soft close)

Packing	15 Sets/Ctn
Available Size	12" to 20"
Finish	Zinc/Black

Drawer Slide Stello (steel)

Packing	15 Sets/Ctn
Available Size	20"
Finish	SS



Quoro Drawer Slide



Required Space

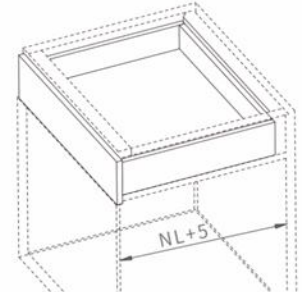

DESCRIPTION

One press to disassemble
 Synchronous running performance
 Built-in height adjustment 0-+3mmmm
 Giving you a gentle closing performance
 Single extension noiseless wooden drawer slide



Soft closing



Max load bearing



Single Ext. Slide



Bolt-type installation technology

Product Info



SPECIFICATIONS

LENGTH	PKG.
250	10 Sets
300	10 Sets
350	10 Sets
400	10 Sets
450	10 Sets
500	10 Sets
550	10 Sets

PUSH OPEN ADJUSTMENT

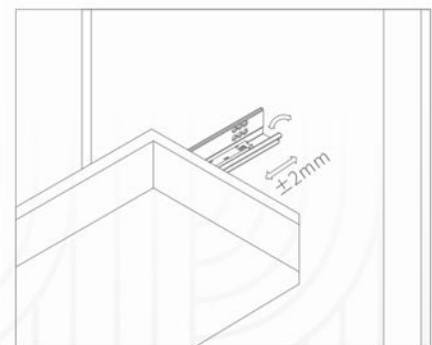
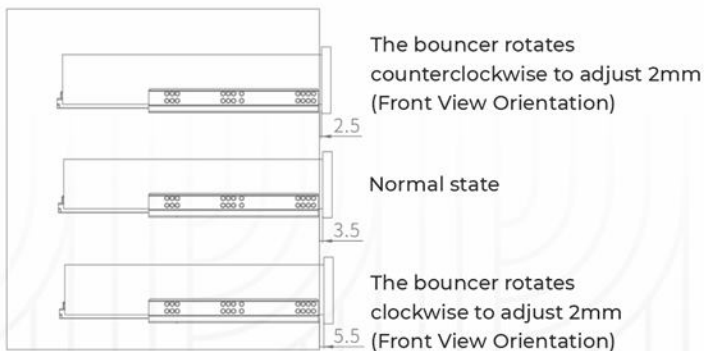

MS Regular Hydraulic Hinges

CRANK	PKG.
0°	50 Sets
8°	50 Sets
16°	50 Sets



SS 2D Hydraulic Hinges

CRANK	PKG.
0°	50 Sets
8°	50 Sets
16°	50 Sets



MS 3D Hydraulic Hinges

CRANK	PKG.
0°	50 Sets
8°	50 Sets
16°	50 Sets



SS 3D Hydraulic Hinges

CRANK	PKG.
0°	50 Sets
8°	50 Sets
16°	50 Sets



MS 3D Hydraulic with 5 Hole (Black)

CRANK	PKG.
0°	50 Sets
8°	50 Sets
16°	50 Sets



Thick Door Hydraulic Hinges

CRANK	PKG.
0°	50 Sets
8°	50 Sets
16°	50 Sets



Short ARM Hydraulic Hinges

CRANK	PKG.
0°	50 Sets
8°	50 Sets
16°	50 Sets



Hydraulic Corner Hinges

CRANK	PKG.
165°	50 Sets





Gas Spring - 9"

Finish : Silver

Capacity : 5 kg., 10kg., 15kg., 20kg., 25kg.



Gas Spring - 9" (soft Close)

Finish : Silver

Capacity : 5 kg., 10kg., 15kg., 20kg.



Gas Spring - 12"

Finish : Silver

Capacity : 10kg., 15kg., 20kg., 25kg., 30kg., 35kg.



Gas Spring - 17" (Bed Fitting)

Finish : Silver

Capacity : 75 kg., 100kg., 125kg., 150kg., 175kg., 200kg.



Bed Fitting Frame

size : 5 Feet, 4 Feet

Thickness : 5mm

Packing : 3 Sets/ Ctn

Weight Capacity : upto 250 kg.

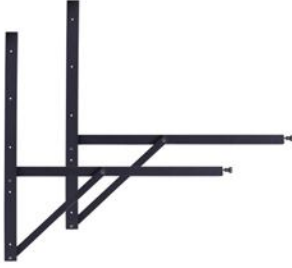

Dining Folding Bracket

Finish : Black

Size : 600mm, 750mm, 900mm, 1200mm, 1500mm.



Table Folding Bracket

Finish : Black

Size : 300mm, 400mm, 500mm, 600mm.



Pocket Channel

Material : Mild Steel

Finish : Zink

Size : 300mm, 350mm, 400mm, 450mm, 500mm.



Ladder Premium Super

Material : Aluminium

Steps : 3, 4, 5, 6, 7.

Capacity : 150kg



Ladder Premium Pro

Material : Mild Steel

Steps : 3, 4, 5, 6, 7.

Capacity : 150kg



Cabinet Door Catcher

Finish : White
Size : M-1, M-2, M-3, M-4, M-5, M-6



Premium Wire Nails

Finish : MS, Zink
Gauge : 12, 14, 17, 18, 19, 20.



Aluminium Shell Rebounder

Finish : Silver
Material : Aluminium + POM + ABS



Landune Gravity Rebounder

Finish : Grey & Dark Grey
Material : POM + ABS



Door Rebounder

Finish : White
Material : ABS



CSK Self Tapping Screw

Material : SS 204cu
Head : Phillips, Slotted
Finish : Nickel
Size : 13mm To 100mm



PAN Self Tapping Screw

Material : Mild Steel
Head : Phillips, Slotted
Finish : Nickel
Size : 13mm To 100mm



Dry Wall Screw

Material : Mild Steel
Head : Bugle
Finish : Black, Nickel
Size : 13mm To 100mm



Machine Screw

Material : SS 204cu
Head : CSK
Finish : Nickel
Size : 19mm To 50mm



Carriage Bolt

Material : Mild Steel
Finish : Nickel
Size : 32mm To 75mm



Self Drilling Screw (Truss)

Material : Mild Steel
Finish : Nickel, Zink
Size : 13mm To 50mm



Self Drilling Screw (Hex)

Material : Mild Steel
Finish : Nickel, Zink
Size : 20mm To 75mm



Self Drilling Screw (CSK)

Material : Mild Steel
Finish : Nickel, Zink
Size : 19mm To 50mm



Chipboard Screw

Material : Mild Steel
Head : Phillips
Finish : Zinc
Size : 50mm To 100mm



Shelf Screw

Material : Stainless Steel
Head : Phillips (Rubber Grip)
Finish : Nickel
Size : 7.5 x 25mm



Innovation
That Shapes Tomorrow.

Get In Touch

MG HARDWARE SOLUTION LLP.

Urja Park, Navagam Road, Near Raghuvir Scrap,
Ahmedabad Highway, Rajkot - 360003

+91 85200 76200

+91 81400 71071

W.: www.mghardwareindia.com

E.: info@mghardwareindia.com